

autel



Collezione Frontali
Frame Collection





SISTINA



CELESIS



ALEX



SARA

FRONTALI / FRAMES



TEMPLETTE / EXTENSIONS

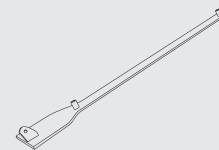

ASTE / TEMPLES

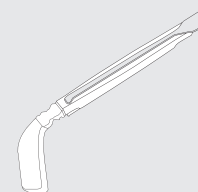
Modello
ModelGenere
GenderColori disponibili
Available colorsMisura
SizeColori disponibili
Available ColorsMisure disponibili
Available sizesColori disponibili
Available Colors

CELESIS

Uomo
MenOro - Nero - Argento
Gold - Black - Silver52
54
56Nero
BlackOro
GoldArgento
SilverRosso
RedModello
ModelMisura
SizeMisura Completa
Total size

Elegance 1

8,3 cm

10,75 cm

Elegance 2 *

9,0 cm

11,5 cm

Elegance 3

9,8 cm

12,25 cm

Elegance 4 *

10,5 cm

13 cm

* Disponibile a breve / Coming soon



ALEX

Donna
WomenOro - Nero - Argento
Gold - Black - Silver52
54
56

SISTINA

Oro - Nero - Argento
Gold - Black - Silver52
55

SARA

Nero - Viola - Rosato
Black - Purple - Pink52
55Nero
BlackMarrone
BrownRadica
BriarArgento
Silver



DAYANA



GERARD



EMIL

STEFY



SONIA



FRONTALI / FRAMES					TEMPLETTE / EXTENSIONS			ASTE / TEMPLES	
Modello Model	Genere Gender	Colori disponibili Available colors	Misura Size	Colori disponibili Available Colors	Metallo 1 anello Metal 1 ring			INCISION	CORTO
	EMIL Uomo Man	Oro - Nero - Radica Gold - Black - Briar	52 54 56 *	 Nero Black	Misure disponibili Available sizes			 Nero/Argento Black/Silver	 Nero Black
	GERARD Uomo Man	Oro - Nero - Bronzato Gold - Black - Bronze	51 53 55 **	 Oro Gold	Modello Model	Misura Size	Misura Completa Total size	 Nero/Rosso Black/Red	 Marrone Brown
	SONIA Donna Women	Oro - Nero Gold - Black	50 52		Mis 0	1,5 cm	10,5 cm	 Marrone/Oro Brown/Gold	 Radica Briar
	STEFY Donna Women	Oro - Nero Gold - Black	52 54		Mis 1	2 cm	11 cm	 Argento/Rosso Silver/Red	 Argento Silver
	DAYANA Donna Women	Oro - Nero Gold - Black	50 52		Mis 2	2,5 cm	11,5 cm		
					Mis 3	3 cm	12 cm		
					Mis 4	3,5 cm	12,5 cm		
					Mis 5	4 cm	13 cm		
					Mis 6	4,5 cm	13,5 cm		
					Mis 7	5 cm	14 cm		

* EMIL MISURA 56 disponibile soltanto radica / EMIL frame size 56 available only in briar

** GERARD MISURA 55 disponibile solo Bronzo / GERARD frame size 55 available only in bronze



LARA



GOLD

DANIEL













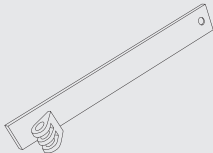
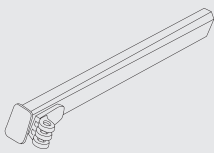
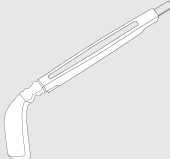
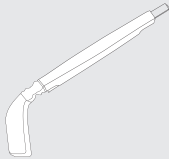
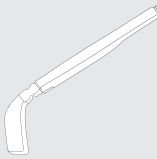









ROMEO



FRONTALI / FRAMES

TEMPLETTE / EXTENSIONS

ASTE / TEMPLES

FRONTALI / FRAMES					TEMPLETTE / EXTENSIONS		ASTE / TEMPLES											
																		
Modello Model	Genere Gender	Colori Colors	Misura Size		Metallo 3 anelli Metal 3 rings	Plastica 3 anelli Plastic 3 rings	INCISION	CORTO	CLASSICO									
	LARA Donna Women	Oro - Radica Gold- Briar	48		 Marrone Brown	 Nero Black	 Nero/Argento Black/Silver	 Nero Black	 Nero Black									
			50															
52																		
54																		
	GOLD Uomo Men	Oro Gold	50		 Oro Gold	 Marrone Brown	 Nero/Rosso Black/Red	 Marrone Brown	 Marrone Brown									
			52															
54																		
Misure disponibili Available sizes																		
	ROMEO Uomo Men	Oro - Radica Gold- Briar	52		Modello Model	Misura Size	Misura Completa Total size	 Marrone/Oro Brown/Gold	 Radica Briar	 Radica Briar								
			54															
			56															
			Misure disponibili Available sizes															
	DANIEL Uomo Men	Oro - Radica Gold- Briar	52		Mis 1	1,5 cm	10,5 cm	 Argento/Rosso Silver/Red	 Argento Silver	 Argento Silver								
			54															
			56															
			Misure disponibili Available sizes															

Taglio con attrezzatura autel, fornito con primo acquisto o su richiesta

Available sizes
STANDARD
Autel extension cutting will be provided when purchasing for the first time or on request

Attrezzo taglio aste / Cut of the temples

Beta Flex Classico

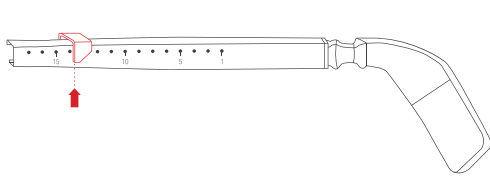

La misura della lunghezza dell'asta si determina utilizzando un occhiale calibro che sarà fornito su richiesta del venditore.

The measurement of the length of the temple is defined using a measuring device that will be provided on request.

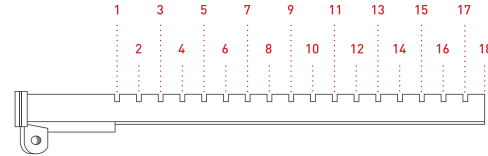

La prolunga può essere tagliata a misura utilizzando un comune seghetto seguendo i riferimenti di taglio in figura.

The extension can be cut to size using a hacksaw and following the references like in the above figure.

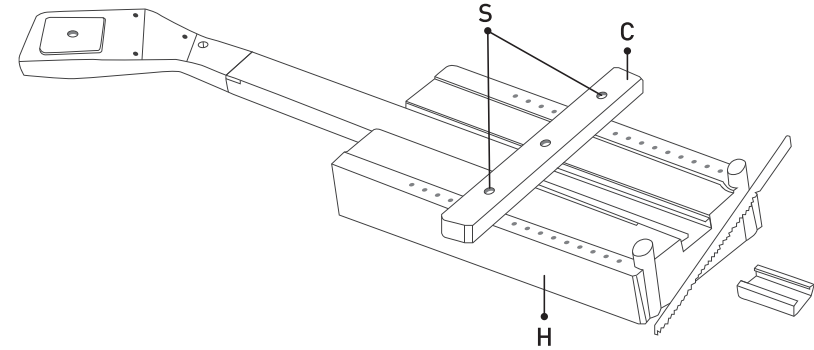

L'asta si può richiedere con la massima lunghezza e il taglio può essere eseguito utilizzando lo speciale strumento di nostra costruzione.

1. Disporre le spine (S) del cursore (C) sulla misura determinata
2. Inserire l'asta nel supporto (H) fino a battuta
3. Tagliare l'asta sporgente con un seghetto e rifinire con una lima

Temple with the maximum length can be ordered. The cut can be performed using Autel's cutting tool.

1. Arrange the pin (S) of the slider (C) at the wanted extent
2. Insert the temple into the holder (H) until it stops
3. Cut the protruding temple with a hacksaw and refinish with a file

Come prendere la misura del frontale How to measure a frame

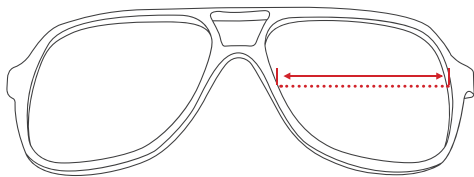

Prendere misura in mm del punto di massima ampiezza della lente. La corrispettiva misura in mm vi fornirà la compatibilità con il frontale più adatto.

Es. 52 mm = frontale misura 52

Take measurement of the point of maximum amplitude of the lens. The corresponding measurement (mm) will provide you with the compatibility with the front more suitable.

i.e. 52 mm corresponds to Frame measure 52

Prendere la misura dell'asta How to measure the temple size

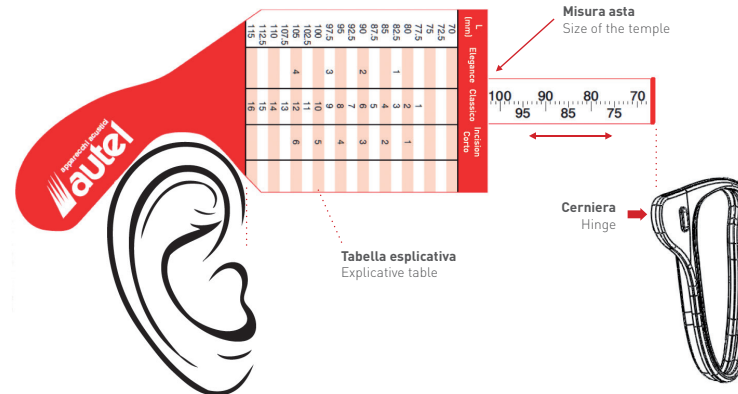

Nella figura di esempio la misura dell'asta è di 103mm, alla quale corrispondono (Tabella di corrispondenza) le seguenti varianti per modello:

- Beta Flex Elegance: templetta numero 4
- Beta Flex Incision e Beta Flex Corto: templetta 5-6
- Beta Flex Classico: tacca 11

Il calibro Autel permette di misurare la distanza tra frontale e orecchio.

Autel's caliper is necessary to take the size between the frame and the ear.

1. Far reggere il frontale dal paziente nella posizione corretta.
2. Posizionare il dorso del calibro sull'orecchio del paziente.
3. Scorrere il cursore fino a far combaciare la parte estrema del calibro con la cerniera del frontale.
4. Leggere la misura indicata a sinistra dall'indice e a destra dal cursore e confrontarla con la tabella sul calibro per definire dimensione templetta.

1. Lay the frame on the patient's face in the correct position.
2. Lay the caliper on the ear following the physiognomies of the patient's head
3. Move the slider up to the frame's hinge
4. Read the size on the left of the measure and look it up in the explicative table to find the corresponding extension size.

In the illustrated example of measurement, temple's size is 103 mm, to which it corresponds (explicative table on Autel's Caliber) the following sizes:

- Beta Flex Elegance model: extension size 4
- Beta Flex Corto or Beta Flex Incision model: extension size 5-6
- Beta Flex Classico: Size 11

Inserimento templetta / *Extension assembly*

Beta Flex **Elegance**

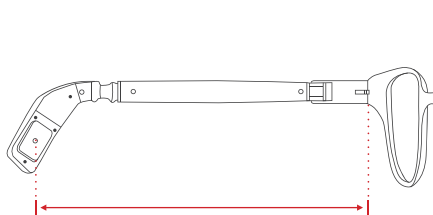

Prendi le misure
Take measurements

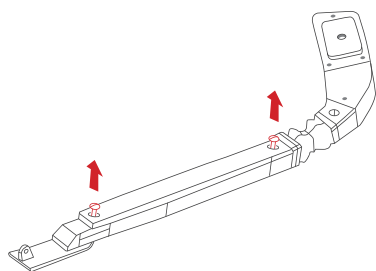

Svitare le viti fino alla parziale estrazione
Unscrew to partial extraction

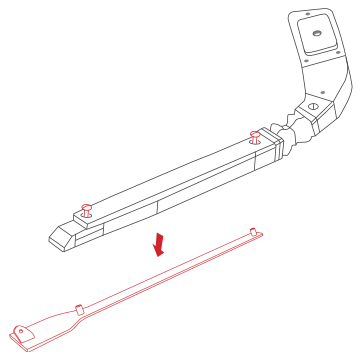

Estrarre la templetta
Remove the extension

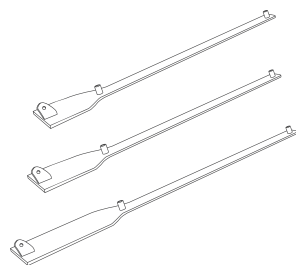

Sostituire con templetta adatta
Replace with suitable extension

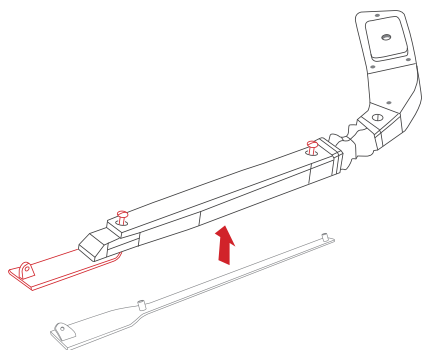

Inserire la prolunga nell'apposito vano
Enter the extension inside the arm

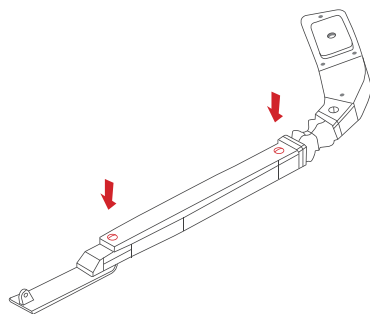

Riavvitare le viti
Tighten screws

Beta Flex **Corto** / Beta Flex **Incision**

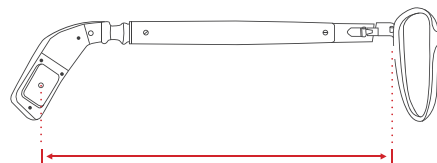

Prendi le misure
Take measurements

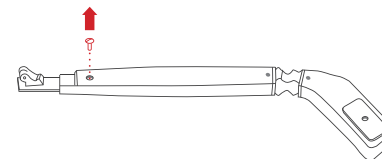

Svitare la vite fino alla parziale estrazione
Unscrew to partial extraction

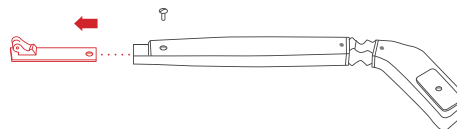

Estrarre la prolunga
Remove extension

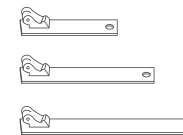

Sostituire con templetta adatta
Replace with suitable extension

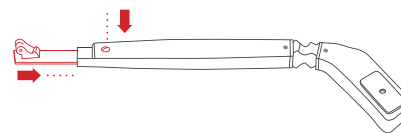

Inserire la prolunga nell'apposito vano e riavvitare
Enter the extension inside the arm and tighten screw

Frontali - Codici Prodotto / Frame - Product Code

Nome Frontale Frame name	Misura Size	Colore / Color		Codice Code
LARA	48	Oro - Radica	Gold - Briar	MEC1627
	50	Oro - Radica	Gold - Briar	MEC840
	52	Oro - Radica	Gold - Briar	MEC841
	54	Oro - Radica	Gold - Briar	MEC1628
ROMEO	52	Oro - Radica	Gold - Briar	MEC842
	54	Oro - Radica	Gold - Briar	MEC843
	56	Oro - Radica	Gold - Briar	MEC1478
GOLD	50	Oro	Gold	MEC480
	52	Oro	Gold	MEC481
	54	Oro	Gold	MEC482
DANIEL	52	Oro - Radica	Gold - Briar	MEC844
	54	Oro - Radica	Gold - Briar	MEC845
	56	Oro - Radica	Gold - Briar	MEC1600
STEFY	54	Oro - Radica	Gold - Briar	MEC996
	52	Oro - Nero	Gold - Black	MEC997
	54	Oro - Nero	Gold - Black	MEC998
SONIA	50	Oro	Gold	MEC999
	52	Oro	Gold	MEC1000
	50	Oro - Radica	Gold - Briar	MEC1001
	52	Oro - Radica	Gold - Briar	MEC1002
	54	Oro - Radica	Gold - Briar	MEC1100
	50	Oro - Nero	Gold - Black	MEC1003
	52	Oro - Nero	Gold - Black	MEC1004
DAYANA	50	Oro	Gold	MEC1005
	52	Oro	Gold	MEC1006
	50	Canna Fucile	Gun Metal	MEC1007
	52	Canna Fucile	Gun Metal	MEC1008

Nome Frontale Frame name	Misura Size	Colore / Color		Codice Code
EMIL	52	Oro	Gold	MEC1011
	54	Oro	Gold	MEC1012
	52	Radica	Briar	MEC1013
	54	Radica	Briar	MEC1014
	56	Radica	Briar	MEC1101
	52	Canna Fucile	Gun Metal	MEC1015
	54	Canna Fucile	Gun Metal	MEC1016
	GERARD	51	Oro	Gold
53		Oro	Gold	MEC1018
51		Oro	Gold	MEC1019
53		Radica	Briar	MEC1020
55		Radica	Briar	MEC1102
51		Canna Fucile	Gun Metal	MEC1021
53		Canna Fucile	Gun Metal	MEC1022
55		Bronzato	Bronze	MEC1626
CELESIS	52	Silver	Silver	MEC2233
	54	Silver	Silver	MEC1641
	56	Silver	Silver	MEC1642
	52	Canna Fucile	Gun Metal	MEC2234
	54	Canna Fucile	Gun Metal	MEC1643
	56	Canna Fucile	Gun Metal	MEC1644
	52	Gold	Gold	MEC2235
	54	Gold	Gold	MEC1645
SISTINA	56	Gold	Gold	MEC1646
	52	Silver	Silver	MEC1648
	55	Silver	Silver	MEC2236
	52	Canna Fucile	Gun Metal	MEC1649
	55	Canna Fucile	Gun Metal	MEC2237
	52	Gold	Gold	MEC1647
55	Gold	Gold	MEC2238	



Autel S.r.l.

Via Taormina, 1 - 00041 Pavona (Rome) - Italy

Ph. +39 06 93 111 31

Fax +39 06 93 100 76

info@autel-italia.it

www.autel-italia.it



© 2014 Autel Srl. All rights reserved.

This publication is intended for experts in the field only.

Features, design and specifications are subject to change without notice.

For updates please view www.autel-italia.it

© 2014 Autel Srl. Tutti i diritti riservati.

Pubblicazione riservata agli operatori del settore.

Dati pubblicati soggetti a modifiche senza preavviso.

Per aggiornamenti consultare www.autel-italia.it

CE 0476

REV 2 / 2014

